

Installation Instructions

VRS (Vertical Rail Systems)



Amico

Preface

IMPORTANT, PLEASE READ CAREFULLY

Thank you for your purchase with Amico Accessories Inc.

This unit is designed for long lasting performance, providing the end user complies with assembly and maintenance procedures. This Instruction Manual is your guide to ensure that you get the best performance out of the equipment. Amico Accessories Inc. is not responsible for any damage as a result of **(but not limited to)** abuse and other problems that may be a direct or indirect result of failure to comply with the instructions provided in this manual.

The tools used in this manual are either imperial or metric. Any metric conversions included for imperial measurements are approximate and may be omitted if only imperial tools and/or hardware are compatible.

Please Note These Key Words and Symbols:



WARNING

Steps where extra care should be taken to prevent injuries and damage.



NOTE

Steps that point out helpful information.

Medical Facility Responsibilities:

Preventive maintenance checks must be performed regularly to maintain the quality and performance of this product. Any parts that may be broken, missing, worn, distorted or contaminated in any way should not be used and all affected parts should be replaced immediately. Should the necessity of any repair be suspected, please contact your local distributor or call 877.264.2697.

Table of Contents

Section 1: Product Specifications	3
Features	3
Section 2: Installation Preparation	3-4
Installation Tools and Parts Required	3
Pre-Installation Information	4
Section 3: Installation on Mounting Platform	5-6
Instructions for Installation	5
Locating The Wall Channel	6
Section 4: Device Installation	7
Section 5: Maintenance, Troubleshooting and Product Classification	7-8
Troubleshooting	7
Preventative Maintenance	7
Cleaning	8
Warranty Information	9

Section 1: Product Specifications

Features

Amico Accessories Inc. Vertical Rails are designed to help make device mounting easier. Vertical Rails are superior equipment management systems used to improve the ergonomics of health care facilities.

VRS (Vertical Rail Systems):

1. Mount flush to any surface
2. Are designed for vertical applications
3. Can be used in conjunction with horizontal rails
4. Are ideal for inlaying in cabinets/case work
5. Add your own laminate to match the aesthetic of your space (0.65" x length of rail)
6. Are available in a wide variety of lengths

Section 2: Installation Preparation

Installation Tools and Parts Required

 **NOTE:** Amico Accessories Inc. does not provide any tools or hardware necessary for installation.

Vertical Rail, #12 x 2½" High Tensile Phillips Sheet Metal or Wood Screws

 **NOTE:** Amount of screws varies depending on channel length.

Section 2: Installation Preparation

Pre-Installation Information (PLEASE READ CAREFULLY BEFORE STARTING)

Although considerable effort has been made in this manual to ensure safety, the installation itself is beyond the control of Amico Accessories Inc. Accordingly, Amico Accessories Inc. will not be responsible for the failure of any such installation.

 **WARNING:** IT SHALL BE THE RESPONSIBILITY OF THE HOSPITAL, ITS CONSULTANTS AND/OR CONTRACTORS TO DETERMINE THAT THE WALL IS ADEQUATE TO SAFELY MOUNT THE SPECIFIC INSTRUMENT. THIS INCLUDES THE SELECTION OF APPROPRIATE FASTENERS AND PROPER INSTALLATION. THE FOLLOWING IS GUIDELINE INFORMATION ONLY. SEE RAIL INSTRUCTIONS FOR SPECIFIC WALL CHANNEL GUIDELINE INFORMATION.

For Other Wall Backings Not Specified in this Manual:

Contact your structural engineer or contact Amico Accessories Inc. to discuss solutions.

Section 3: Installation on Mounting Platform

Instructions for Installation (Non-Seismic Applications)

Support backing for 5/8" (15.88 mm) gypsum board walls for wall mounted instrumentation.

This anchorage will allow for a quick and easy installation of the vertical rail. 16 Gauge steel will prevent the material from extruding up the shank of the screw (stripping). 1 1/64" (4.37 mm) diameter holes are required for #12 x 2-1/2" Phillips flat head screws (4) installed down the center line at a maximum of 6" (15.24 mm) apart, starting 2.5" (6.35 cm) from the top.

A 2" x 4" (5.08 cm X 10.16 cm) wood stud may be used if allowed by local building codes.

Minimum Requirements:

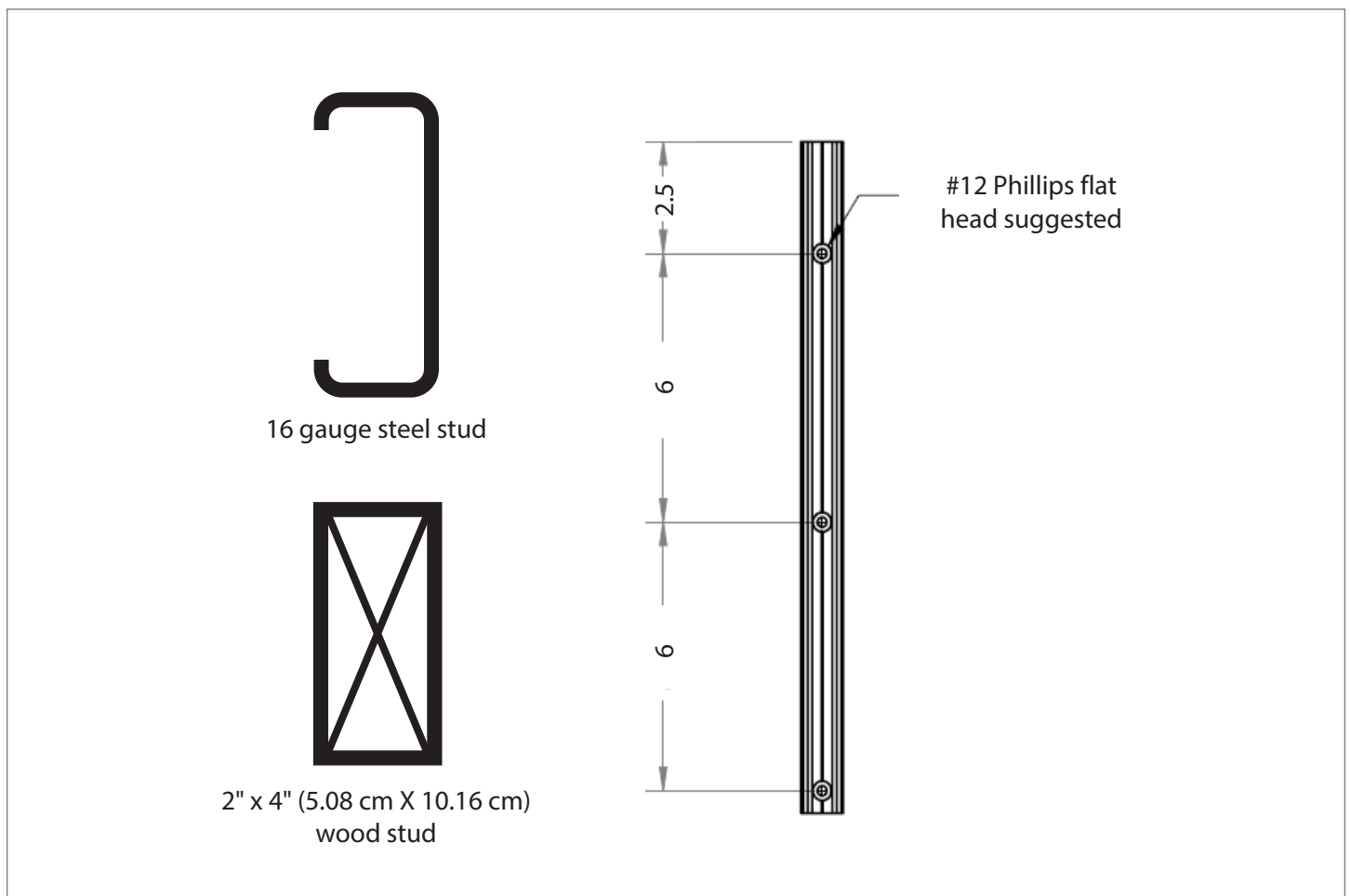

Figure 1

This is not acceptable in seismic sensitive areas and not allowed in California. Seismic wall channel installation instructions are available separately.

Instructions and the illustrations covering the specific instrument to be mounted should be reviewed prior to installation of the wall channel.

Section 3: Installation on Mounting Platform

It shall be the responsibility of the hospital, its consultants and/or contractors to determine that the wall is adequate to safely mount equipment. This includes the selection of appropriate fasteners and the proper installation of the same. In new construction and remodeling work where the wall covering can be entirely or partly removed, a 16 gauge steel stud should be located for the purpose of attaching the wall channel. The following is provided as guideline information only.

Locating the Wall Channel

Generally, the bottom edge of the vertical rail is placed 56" (142.24 cm) above the floor, plus or minus 4" (10.16 cm). Some devices may require lower channel placement.

The bottom of the device will be 4.5" (11.43 cm) above the bottom of the channel.

Access to device controls should be considered before mounting the vertical rail. Allow clearance on either side of the rail center line to clear objects such as over bed lighting, privacy curtains, adjacent walls or columns, door swing arcs, etc. Power and signal outlets should also be considered when selecting a rail location. Avoid oxygen, vacuum and air outlets and allow space for attendant flowmeters and regulators.

Drywall (Gypsum Board) Over Sheet Metal:

The vertical rail must be anchored into the stud. Locate the exact center line of the stud. Drill 11/64" (4.37 mm) diameter holes on the center line of the rail (2.5" [6.35 cm] from the top and bottom of the vertical rail and every 6 inches [15.24 cm] minimum in between). The drill hole size corresponds to the screw size. Different screws require different hole sizes.

 **NOTE:** the recommend drill hole size is for #12 X 2-1/2" Phillips flat head sheet metal screws. Countersink the holes 82° and install using at least #10 X 2-1/2" Phillips flat head sheet metal screws. Install the top screw and level the rail, then mark and drill the other holes.

Drywall (Gypsum Board) Over Wood Studs:

The vertical rail must be anchored into the stud. Locate the exact center line of the stud. Drill 11/64" (4.37 mm) diameter holes on the center line of the rail (2.5" [6.35 cm] from the top and bottom of the vertical rail and every 6 inches [15.24 cm] minimum in between). The drill hole size corresponds to the screw size. Different screws require different hole sizes.

 **NOTE:** the recommend drill size is for #12 X 2-1/2" Phillips flat head wood screws. Countersink the holes at 82° and install using at least #10 X 2-1/2" Phillips flat head wood screws. Install the top screw and level the rail, then mark and drill the other holes.

Special Applications:

Contact Amico Accessories to discuss solutions to wall mounting problems for any situation not covered by these guidelines.

 **WARNING:** ALL RAILS ARE LIMITED TO A WEIGHT OF 20 LBS (9.07 KG) AT THE RAIL.

Section 4: Device Installation

See the Instruction Manual for the device you are installing for instructions about mounting it on VRS Rail.

Section 5: Maintenance, Troubleshooting and Product Classification

Troubleshooting

Symptom	Possible Cause	Solution
The rail is loose/unstable	The mounting screws have loosened	Contact structural engineer to discuss solution

Preventive Maintenance

⚠ WARNING: ALL PRODUCTS REQUIRE PERIODIC INSPECTION AND MAINTENANCE TO PERFORM OPTIMALLY AND ACHIEVE MAXIMUM OPERATION LIFE.

⚠ WARNING: THE INTERVALS SHOWN BELOW ARE RECOMMENDED. MAINTENANCE SCHEDULES SHOULD BE MORE FREQUENT FOR PRODUCTS THAT SEE HEAVY USE.

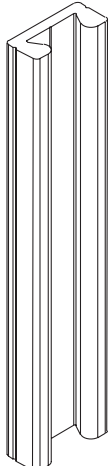
Area	Maintenance	Period (Months)
	<p>Entire VRS rail:</p> <p>A) Visually inspect for any loosening of any mounting screws on any VRS.</p> <p>B) Check rail screws every six months.</p>	6

Section 5: Maintenance, Troubleshooting and Product Classification

Cleaning

 **WARNING:** THE CLEANING CHEMICALS AND METHODS BELOW ARE NOT MEANT FOR CONTROLLING ANY INFECTIONS. IT SHALL BE THE RESPONSIBILITY OF THE HOSPITAL OR THE HOSPITAL'S INFECTION CONTROL OFFICER TO SANITIZE THE EQUIPMENT.

 **WARNING:** PLEASE DO NOT SPRAY ANY CHEMICAL DIRECTLY ONTO THE PRODUCT. APPLY ONTO A SOFT CLOTH AND WIPE CLEAN TO PREVENT CHEMICALS GETTING INTO THE INTERNAL COMPONENTS OF THE PRODUCT.

The mounting assembly may be cleaned with most mild, non-abrasive solutions commonly used in the hospital environment (e.g. diluted bleach, ammonia, or alcohol solutions). The surface finish will be permanently damaged by strong chemicals and solvents such as acetone and trichloroethylene. Steel wool or other abrasive material should never be used. Damage caused by the use of unapproved substances or processes will not be warranted. It is recommended that you test any cleaning solution on a small area of the product that is not visible to verify compatibility. Never submerge the product and do not allow liquids to enter it. Wipe any cleaning agents off the product immediately using a water-dampened cloth. Dry the product thoroughly after cleaning.

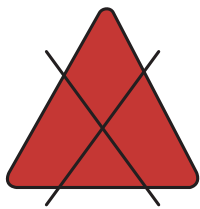

No Acetone

Acetone is a colorless, mobile, flammable liquid

Acetone

Figure 1

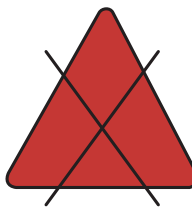

No Trichloroethylene

Trichloroethylene is a chlorinated hydrocarbon commonly used as an industrial solvent

Trichloroethylene

Figure 2



Warranty Policy - Equipment Mounting Solutions

Amico Accessories Inc. warrants all mounting accessories to be free from defects in material and workmanship for a period of twelve (12) months from the date of shipment. Within this period Amico Accessories Inc. will repair or replace any part which is proven to be defective.

Amico Accessories Inc. will warrant its materials to be free from defect for an additional period of four (4) years, (five [5] years from the date of shipment). Within this period, Amico Accessories Inc. will replace any part which is proven to be defective, at no charge. Shipping and Installation costs after the first twelve (12) months will be borne by the Customer.

This warranty is valid only when the product has been properly installed according to Amico Accessories Inc. specifications, used in a normal manner and serviced according to factory recommendations. It does not cover products that are not manufactured by Amico Accessories Inc. It does not cover failures due to damage which occurs in shipments or failures which result from accidents, misuse, abuse, neglect, mishandling, alteration, misapplication or damage that may be attributable to acts of God.

Amico Accessories Inc. shall not be liable for incidental or consequential damages resulting from use of equipment.

All claims for warranty must first be approved by Amico Accessories Inc. A valid Return Goods Authorization (RGA) number must be obtained from Amico Accessories Inc. prior to commencement of any service work. Warranty work, which has not been pre-authorized by Amico Accessories Inc., will not be reimbursed.

AMICO ACCESSORIES INC. DOES NOT HONOR VERBAL STATEMENTS CONCERNING THE WARRANTY.

The distributor and/or dealer are not sanctioned to create verbal warranties about the product described in this agreement. Any statements will not be honored or be made part of the agreement of sale. This document is the final complete and exclusive terms of the agreement.

THIS WARRANTY IS INCLUSIVE AND REPLACES ALL OTHER WARRANTIES.

Amico Accessories Inc. shall not, under any circumstances be liable for incidental or consequential damages including, but not limited to, profit, loss of sales or injuries to person(s) or property. Correction of noncompliance as noted above will result in completion of all liabilities of Amico Accessories Inc., whether based on agreement, neglect or changed materials, designs or specifications without notice.

All claims for warranty must first be approved by Amico Accessories Inc. Service Department: accessories@amico.com or 1.877.264.2697. A valid Return Goods Authorization number must be obtained from Amico Accessories Inc. prior to commencement of any warranty claim.

Notes

www.amico.com

Amico Accessories Inc. | 85 Fulton Way, Richmond Hill, ON L4B 2N4, Canada
Toll Free Tel: 1.877.264.2697 | Tel: 905.763.7778 | Fax: 905.763.8587
Email: info@amico-accessories.com | www.amico.com