

Mobile Computer Workstation Accessories

Hummingbird SmartDrawers



Technical Specifications

Compatible Carts

Any powered Hummingbird LCD/laptop cart with electric lift.
Any 3-row cabinet SmartDrawers on a cart with ergonomic keyboard tray is recommended to pair with extra-long (XL) electric lift.

Features

- Unlock drawers to access supplies as desired
- Unlock drawers from control interface
- Ergonomic design for reduced clinician fatigue
- Removable drawers and dividers to accommodate any workflow
- Emergency manual key lock override

Material/Surface

- Designed to meet infection control and prevention standards using non-porous, easy-to-clean materials (aluminum, steel, ABS plastic, nylon)
- Use Caviwipes or other disinfectant wipes (no abrasives, solvents, or trichloroethylene)

Divider

- **Slim Drawer:** 3 dividers are available to further divide the slim drawer into 4 small compartments, each at 2.7" (6.88 cm) deep. **(Figure 4)**
- **Wide Drawer:** 3 dividers are available to further divide the wide drawer into 4 compartments, each 3.8" (9.70 cm) wide. **(Figure 5)**

Admin Settings

- Manual drawer configuration
- Drawer unlock time-out
- Drawer label editing permission
- 2-factor authentication drawer access-control (not applicable to unlocking all-together cabinets)
- Auto-locking status at power-up
- Drawer access inactive time-out
- Guest user-access permission
- SmartDrawers access PIN settings
- SmartDrawers self-recognition

Label

- Clear label covers fit labels size 1.0" (2.50 cm) W x 3.0" (7.60 cm) H
- Available on-screen drawer label editing for paperless labeling

User Controls

- Locking drawer when pushed all the way in
- Unlocking specific drawers as desired (or all drawers in one click for the unlocking all-together option)
- Drawer label editing, if permitted

BirdsEye Integration

Future proof to be compatible with BirdsEye fleet management software integration

Loads

Maximum Load of Each Drawer:

- **Slim Drawer:** 1.1 lbs (0.5 kg)
- **Wide Drawer:** 4.4 lbs (2.0 kg)

Key Dimensions

Outside Dimensions (without mounting bracket):

- **Width:** 17.9" (45.47 cm)
- **Depth:** 16.3" (41.50 cm)
- **Height:**
 - 1-Row: 4.8" (12.17 cm)
 - 2-Row: 8.5" (21.70 cm)
 - 3-Row: 12.3" (31.22 cm)

Drawer Pull-out Length: 9.8" (24.81 cm) **(Figure 1)**

Physical Weight:

Total physical weight is the sum of the weight of the selected cabinet and the corresponding drawers.

- **Individually Unlocking Cabinet:**
 - 1-Row: 18.28 lbs (8.29 kg)
 - 2-Row: 26.33 lbs (11.94 kg)
 - 3-Row: 33.73 lbs (15.30 kg)
- **Unlocking All-together Cabinet:**
 - 1-Row: 17.98 lbs (8.16 kg)
 - 2-Row: 25.73 lbs (11.67 kg)
 - 3-Row: 32.25 lbs (14.63 kg)

Every row of 1 wide drawer (with dividers) adds 2.52 lbs (1.14 kg).

Every row of 4 slim drawers (with dividers) adds 3.20 lbs (1.45 kg).

E.g. Individually unlocking 3-row cabinet with 2 rows of wide drawers and 1 row of slim drawers would be 33.73 lbs (15.30 kg) + 2 x 2.52 lbs (2 x 1.14 kg) + 3.20 lbs (1.45 kg) = 41.97 lbs (19.03 kg) total.

Storage Capacity

Inside Dimensions (with no drawer dividers) & Volume:

- **Each Slim Drawer:** 3.2" (8.12 cm) W x 11.7" (29.71 cm) D x 2.9" (7.36 cm) H
- **Each Row of 4 Slim Drawers:** 0.0073 m³
- **Each Wide Drawer:** 13.6" (34.54 cm) W x 11.4" (28.95 cm) D x 2.9" (7.36 cm) H
- **Each Row of 1 Wide Drawer:** 0.0075 m³

Shipping Dimensions & Weight

SmartDrawers typically ship with the compatible cart in one skid. Add physical weight to the cart model for total shipping weight.

Warranty

- 3-Year Warranty for electrical components
- 5-Year Warranty for mechanical components

Cabinet Layouts



1-Row Cabinet



HMA-SDRW-A-400
4 Slim Drawers

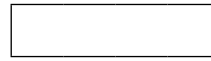

HMA-SDRW-1-100
1 Wide Drawer

2-Row Cabinet



HMA-SDRW-B-110
2 Wide Drawers

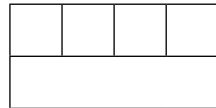

HMA-SDRW-B-410
4 Slim Drawers & 1 Wide Drawer

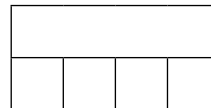

HMA-SDRW-B-140
1 Wide Drawer & 4 Slim Drawers

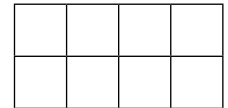

HMA-SDRW-B-440
8 Slim Drawers

3-Row Cabinet

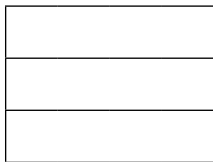

HMA-SDRW-C-111
3 Wide Drawers

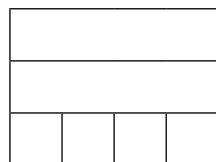

HMA-SDRW-C-114
4 Slim Drawers & 2 Wide Drawers

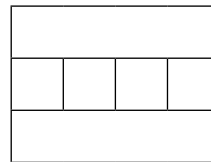

HMA-SDRW-C-141
4 Slim Drawers & 2 Wide Drawers

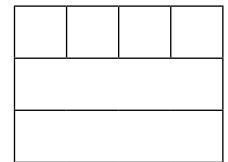

HMA-SDRW-C-411
4 Slim Drawers & 2 Wide Drawers

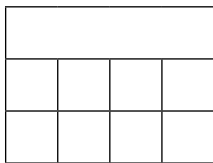

HMA-SDRW-C-144
1 Wide Drawer & 8 Slim Drawers

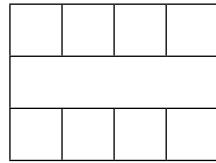

HMA-SDRW-C-414
1 Wide Drawer & 8 Slim Drawers

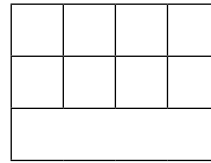

HMA-SDRW-C-441
1 Wide Drawer & 8 Slim Drawers

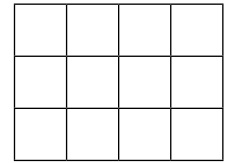

HMA-SDRW-C-444
12 Slim Drawers

All cabinets are available with an "all-unlocking" option. Please contact your Amico sales representative for details.

Figure 1: Cabinet Width & Depth (Without Mounting Bracket)

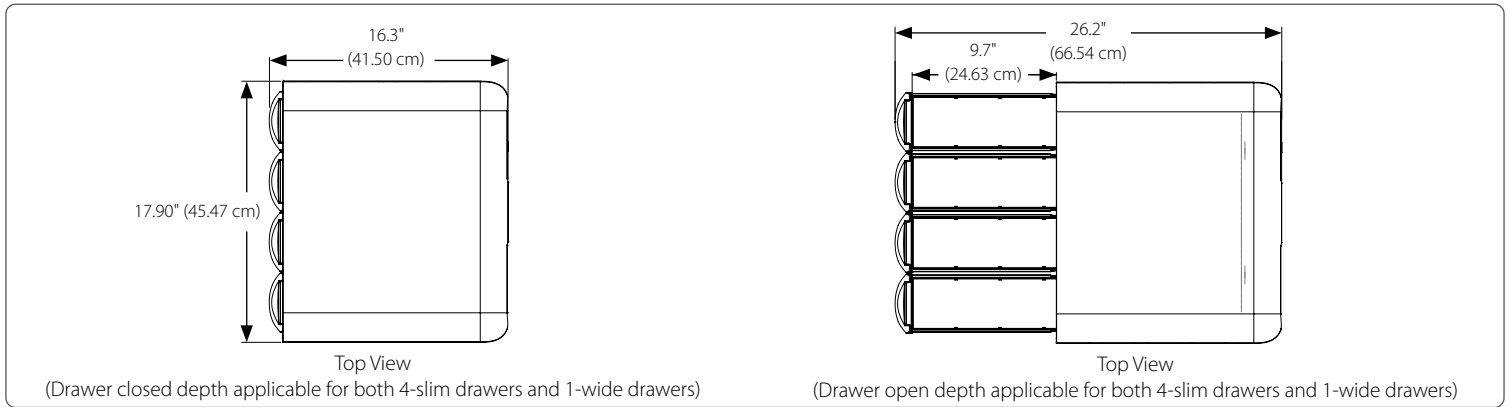

Figure 2: Cabinet Height (Without Mounting Bracket)

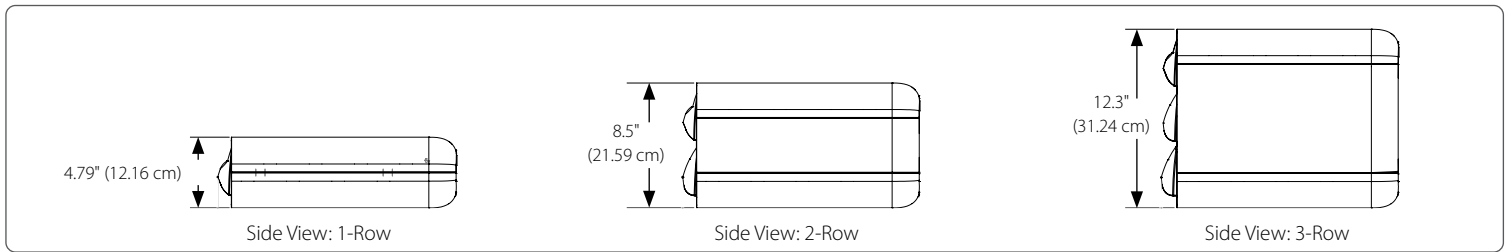

Figure 4: Slim Drawer (With 3 Dividers)

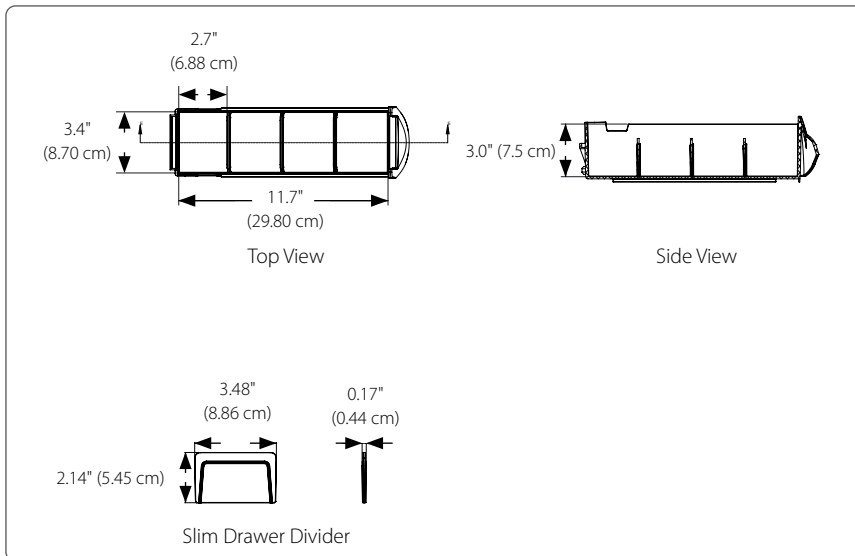
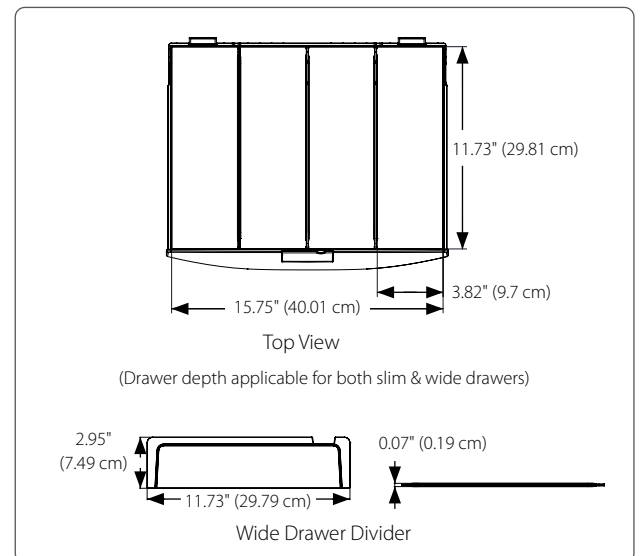
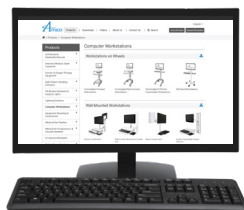

Figure 5: Wide Drawer (With 3 Dividers)



Add dimensions of the bin interior and exterior, along with the compartments that are made if using the dividers.

Please visit www.amico.com for all technical specifications, installation instructions, detailed AutoCAD drawings, and more Mounting Solutions.



Distributed By:

