

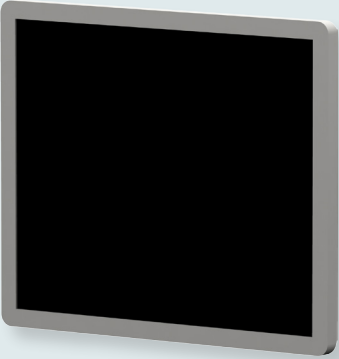





GE Healthcare

Ordering Guide Reference Chart



Device	Mounting Kit	Mounting Platform	Restrictions	Add-Ons
 <p>GE Solar 8000 Monitor 15" : 11.7 lbs (5.0 kg)* Monitor 17" : 11.7 lbs (5.0 kg)* Monitor 19" : 15.4 lbs (7.0 kg)*</p>	<p>N/A (The Solar 8000 Flat Panel has a standard VESA mounting pattern)</p>	 AHM-057	<p>N/A</p>	 RAC4  Trim Knob Keypad  Solar 8000 Base Unit
	 GE-8000-SM-FH, MON-VESA-ADA 2.88 lbs (1.30 kg)*	 Solar 8000 Base Unit		<p>Requires an additional mount, see the Solar 8000 Base Unit details below</p>

*Weight provided to help approximate mounting capacity. For reference only.

GE Healthcare Ordering Guide Reference Chart













Device	Mounting Kit	Mounting Platform	Restrictions	Add-Ons
 <p>Trim Knob Keypad 1 lb (0.45 kg)*</p>	 <p>GE-KEY8K-PLT-00 1.5 lbs (0.68 kg)*</p>	 <p>AHM-057</p>	<p>This unit sandwiches between the flat panel and the AHM/SSM or the GE-8000 SM-FH</p>	<p>N/A</p>
		 <p>SSM-057</p>		
 <p>Solar 8000 Base Unit 12.3 lbs (5.6 kg)*</p>	<p>N/A (The Solar 8000 Base Unit has a mounting plate build into the bottom)</p>	 <p>GE-8000-MON-00</p>	<p>The GE-8000-MON-00 is not compatible with the GE-8000-SM-FH</p>	<p>N/A</p>
		 <p>AHM-050</p>		
		 <p>SSM-050</p>		
 <p>RAC4 7.8 lbs (3.4 kg)*</p>	 <p>GE-RAC4-SI-00 1.5 lbs (0.68 kg)*</p>	 <p>AHM-057</p>	<p>Mounts below with primary device on AHM/SSM</p>	<p>N/A</p>
		 <p>SSM-057</p>		

*Weight provided to help approximate mounting capacity. For reference only.

GE Healthcare Ordering Guide Reference Chart



Device	Mounting Kit	Mounting Platform	Restrictions	Add-Ons
 <p>Dual RAC4 15.6 lbs (6.8 kg)*</p>	 <p>GE-RAC4-SS-00 2.8 lbs (1.27 kg)*</p>	 <p>AHM-057</p>	Mounts below with Primary Device on AHM	N/A
 <p>Cuffs and Patient Leads</p>	N/A	 <p>100609-MON-BB</p>	N/A	N/A
 <p>GE Unity 2.4 lbs (1.1 kg)*</p>	 <p>GE-UNITY-PLT-00 0.28 lbs (0.12 kg)*</p>	 <p>GE-8000-MON-00</p>	N/A	N/A
 <p>GE PDM 2.8 lbs (1.3 kg)*</p>	N/A	 <p>GE-PRNPD-LBT-MON</p>	N/A	N/A

*Weight provided to help approximate mounting capacity. For reference only.

GE Healthcare Ordering Guide Reference Chart

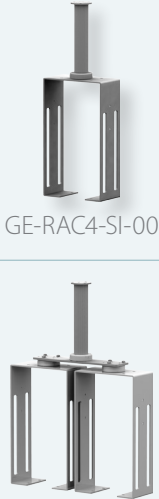

Device	Mounting Kit	Mounting Platform	Restrictions	Add-Ons
 <p>PRN50 5.7 lbs (2.6 kg)*</p>	 <p>GE-PRNPD-LBT-00 0.38 lbs (0.17 kg)*</p>	 <p>GE-RAC4-SI-00 GE-RAC4-SS-00</p>	<p>N/A</p>	<p>N/A</p>

*Weight provided to help approximate mounting capacity. For reference only.