

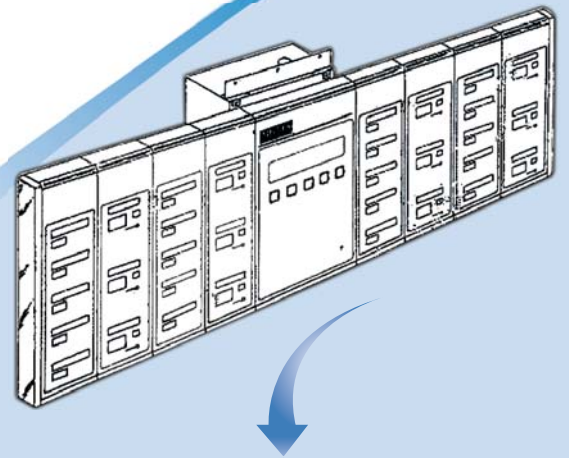

MedæS Integrated Alarm Retro-Fit Manual v1.2



US LISTED

PRODUCT SPECIFICATIONS

The Amico retro-fit alarm will allow an existing Medæx integrated alarm to be replaced, without removing the existing back box and pipe-stubs.

The filler frame enables the Amico Alert-2 Microprocessor alarm front assembly to sit on the wall of the existing alarm panel box. The filler frame acts like a spacer between the integrated box and the front assembly. Please make sure that the gas is turned off before the retro-fit alarm is installed.

INSTALLATION INSTRUCTIONS

Remove all internal components of the integrated alarm (mother board, power supply, sensors and all wiring). Remove the front frame and the display modules from the back box.



Ensure that the back box is clear of ALL screws, studs, stand-offs and insert tabs. Bend the lower front lip of the alarm box. Ensure that the lip is flat.



Add the power supply to the far left corner of the back box assembly. Use 4 tapping screws to hold power supply into box. Use tapping screws for grounding wires. Please note, tapping screws are not supplied by Amico.

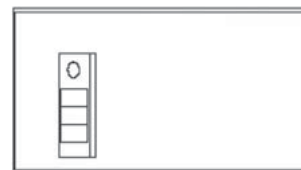

Remove the DISS fitting from the sensors that are mounted remotely.

Connect the Amico Alert-2 sensor, which contains a DISS fitting (nut and nipple).

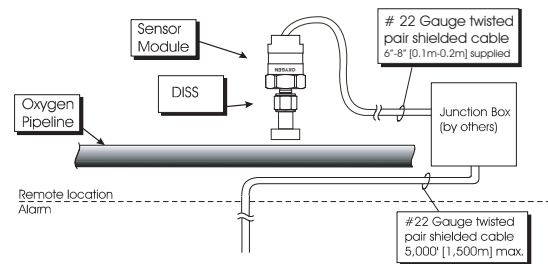

Add the Amico filler frame to the wall surface. Ensure that the box on the wall is in the center of the filler frame.

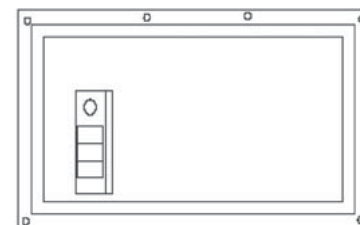

Install the front assembly and follow the "Installation & Operation Manual of the Alert-2 Alarm". Also supplied with the Retro-Fit alarm.

A complete alarm assembly conversion from Madaes to Amico.

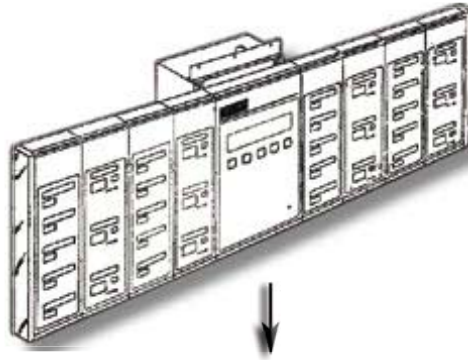

PRODUCT DIMENSIONS

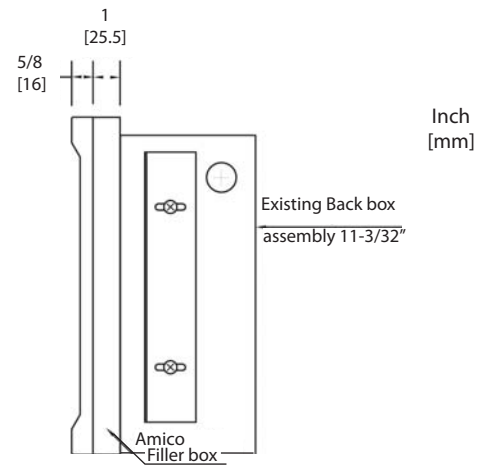
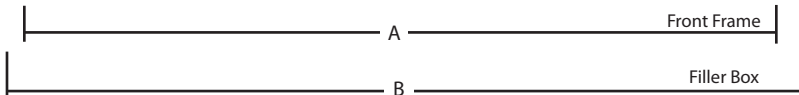
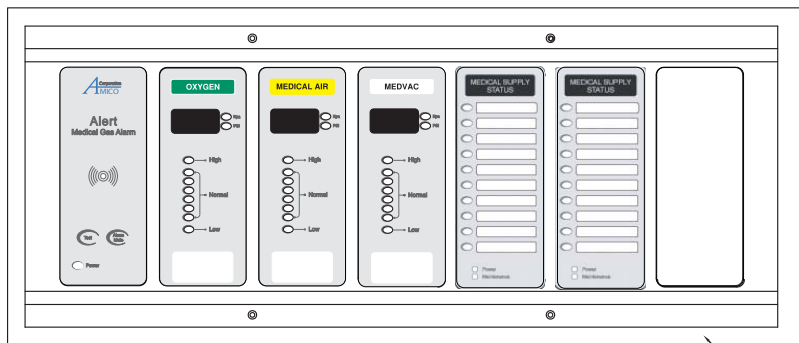

Number of Display Modules	A	B	Gang
1 module	8 (203)	9.5 (241)	2
From 1 to 2 modules	12 (305)	12.75 (324)	3
From 1 to 3 modules	15 (381)	16 (406)	4
From 1 to 4 modules	18 (465)	19.3 (490)	5
From 1 to 6 modules	25 (635)	25.9 (658)	7



85 Fulton Way, Richmond Hill
Ontario, L4B 2N4, Canada

31 Sprague Avenue, Amityville
NY 11701, USA

Toll Free Tel: 1.877.462.6426
Toll Free Fax: 1.866.440.4986
Tel: 905.764.0800 | Fax: 905.764.0862
www.amico.com

represented by: